



COPY RIGHT



2021IJIEMR. Personal use of this material is permitted. Permission from IJIEMR must be obtained for all other uses, in any current or future media, including reprinting/republishing this material for advertising or promotional purposes, creating new collective works, for resale or redistribution to servers or lists, or reuse of any copyrighted component of this work in other works. No Reprint should be done to this paper, all copy right is authenticated to Paper Authors

IJIEMR Transactions, online available on 13th June 2022.

Link : <https://ijiemr.org/downloads/Volume-11/Issue-06>

Title: **Google Assistant Controlled Smart Home**

volume 11, Issue 06, Pages: 1561-1566

Paper Authors **S. Towseef Ahmed, S. Bhavya, P. Bhavani, S. Divya sai, B. Jasmine**



USE THIS BARCODE TO ACCESS YOUR ONLINE PAPER

Google Assistant Controlled Smart Home

S. Towseef Ahmed¹, S. Bhavya², P. Bhavani², S. Divya sai², B. Jasmine²

¹Assistant Professor, Dept. of ECE, GPCET, Kurnool.

²UG Student, Dept. of ECE, GPCET, Kurnool

ABSTRACT

The idea behind Google assistant-controlled Smart Home is to control home devices with voice. In the market there are many devices available to do that, but making our own is awesome. In this project, the Google assistant requires voice commands. Adafruit account which is a cloud based free IoT web server used to create virtual switches, is linking to IFTTT website abbreviated as “If This Then That” which is used to create if else conditional statements. The voice commands for Google assistant have been added through IFTTT website. In this home automation, as the user gives commands to the Google assistant, Home appliances like Bulb, Fan and Motor etc., can be controlled accordingly. The commands given through the Google assistant are decoded and then sent to the microcontroller, the microcontroller in turn control the relays connected to it. The device connected to the respective relay can be turned On or OFF as per the users request to the Google Assistant. The microcontroller used is NodeMCU (ESP8266) and the communication between the microcontroller and the application is established via Wi-Fi (Internet).

INTRODUCTION

Smart Home refers to the automatic and electronic control of household features, activities, and appliances. The utilities and features of our home can be easily controlled via Internet. There are three main elements of a home automation system: sensors, controllers, and actuators. In this trending world, Internet of Things is being given extreme importance. In that, Automation, leads to have less effort and much efficiency. By using IoT, we are successful in controlling the appliances in various areas, in which one of them is to control the home automation by using Node Microcontroller. We can also use other boards like raspberry pi, beagle bone etc., In the present-day technology, the whole work is done through communication so the effective way of communication can be done through voice. As the speech enabled, home automation system deploys

the use of voice to control the devices. It mainly targets the physically disabled and elderly persons. The home automation will not work if the speech recognition is poor. The speech given by the user will be given as input to the Microphone. Microphone recognizes the speech given by the person and sends it to the recognizing module. It searches for the nearest word even if there are any disturbances in it. If the command (ON/OFF) is given, the action is done.



Fig 1 : Smart Home

Internet of Things

The major concept using in the Google assistant-controlled Home automation is the Internet of Things. The Internet of Things (IoT) can be connecting various types of objects like smart phones, personal computer and tablets to the internet, which brings new-fangled type of communication between things and things, and things and people. The Fig 1.1 shows the Home automation system. Any man-made objects that can be assigned an IP address and it has the ability to transfer data successfully over a network, the interaction through a network is called IoT. The internet helps us to bring immediate solutions for many problems and able to connect from any of the remote places. The Internets of Things technology is used to come in with innovative idea and large development space for smart homes to improve the living standards of life. The growth of the Internet of Things will reform a number of sectors, like healthcare, automation energy, transportation, etc. The cloud computing can be used in such case to implement the IoT infrastructure that augmented with sensors and actuators to monitor and control

“things” from anywhere .

Node MCU ESP8266

Features

- Very Low cost
- Pre-programmed with an AT command set firmware
- Growing Community
- Enough on-board processing power to deal with sensors through GPIO
- Operating at 3.3V
- Can draw upto 170mA of current.

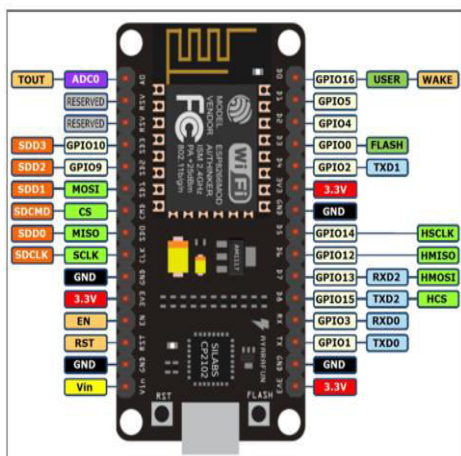

Fig 2 : Node MCU Pin Diagram

PROPOSED METHOD

A home automation system allows users to control electric appliances of varying kind. Many existing, well established home automation systems are based on wired communication. This does not pose a problem until the system is planned well in advance and installed during the physical construction of the building. IoT is a system that uses computers or mobile devices to control basic home functions and features automatically through Internet from anywhere around the world. Internet or IP protocol-based communication in home automation systems is always a popular choice. The capacity of a product or system to communicate in a standard way with other products or system is Interoperability. The proposed system eliminates the complication of wiring in case of wired automation. Considerable amount of power supply is also possible. Operating range is more than the Bluetooth.



Fig 3 : Block Diagram of Smart home

Google assistant-controlled home automation, first the user should have an Android smartphone with Google assistant installed in it. When the user gives commands to the Google assistant, the commands will be checked with the commands in the IFTTT website which are already set. Then the next step is setting up the virtual switches in Adafruit website. If the commands given by the user matches with the commands in the IFTTT website, then depending on those commands, the virtual switches in Adafruit will be turned ON or OFF. This will be sensed by the Node microcontroller and it will turn ON or OFF the relay depending on the commands. All this will be done over the Internet. In this, the relay will act as a switch and the home appliances connected to the relay will be turned on or off. The number of home appliances connected depends upon the number of relays.

ADAFRUIT SETUP

Create account at www.adafruit.io

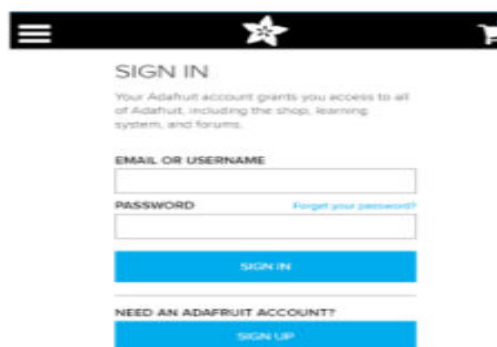

Fig 4 : Adafruit Sign In Page

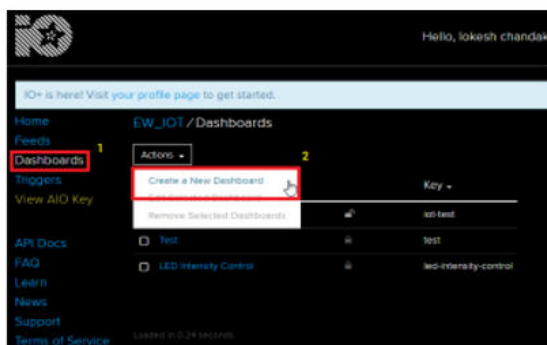

Fig 5 : Adafruit Dashboard

Now, create dashboard at Adafruit. This dashboard is a user interface to control things remotely. After following above steps, provide name to the dashboard and save it. Users can see their dashboard as follows now, create feed (user interface) to control light On-Off. To create it, just click on '+' symbol and select toggle feed shown below

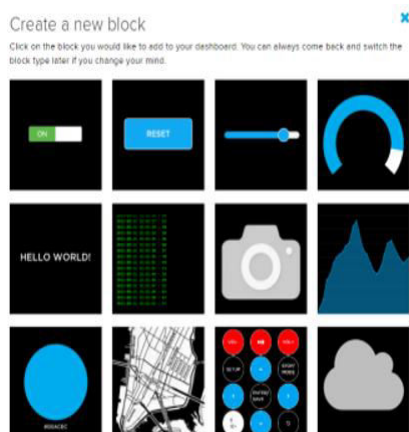

Fig 6 : Creating blocks for switches



Fig 7 : Block Settings for turning ON and OFF

After selecting toggle feed, pop-up window appears as shown.

Here, 0 is used as (OFF) and 1 is used as (ON) text for button and then click on create. This will create toggle button on your dashboard which can be used to control things remotely. Now, dashboard is

ready for IoT application like home automation. **IFTTT**

If This Then That, also known as IFTTT, is a free web-based service to create chains of simple conditional statements, called applets. An applet is triggered by changes that occur within other web services such as Gmail, Facebook, Telegram, Instagram, or Pinterest. For example, an applet may send an e-mail message if the user tweets using a hashtag, or copy a photo on Facebook to a user's archive if someone tags a user in a photo. IFTTT is an initialism for "If This Then That. In addition to the web-based application, the service runs on iOS and Android. IFTTT users created about 20 million recipes each day. All of the functionalities of the Do suite of apps have since been integrated into a redesigned IFTTT app.



Fig 8 : IFTTT Sign in Page

IFTTT SETUP

IFTTT is used to use google assistant service and Adafruit service in chain. So, Google assistant is used to control light of my home by saying Ok google, turn the light ON or OFF. Then IFTTT interpret the message and can send it to Adafruit's dashboard as an understandable command to the created feed. First step is creating account on IFTTT.

Note: Create account on IFTTT by using same e-mail id which have been used for Adafruit. After account creation, click on My Applets and then select New Applet shown below

After selecting a new applet, we get a new page in which we should click on to this as shown in Fig. There are a number of places that the connection

between our voice and the light can break down. If the light isn't changing when the user speaks, there are a few things should be checked. The light should be turned ON or OFF when the user toggles the switch on the Adafruit IO.

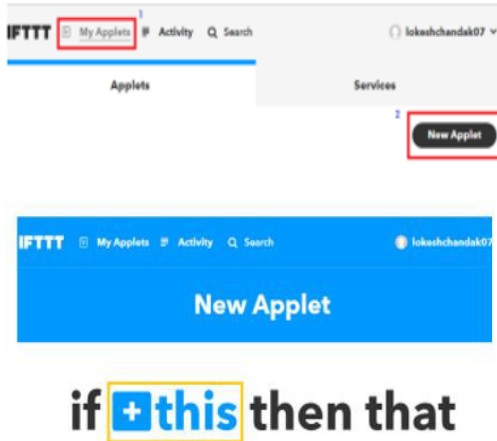

Fig 9 : Creating IF statement

If not, the ESP8266 is either not connecting to the server, not subscribing to the feed, or not checking for the correct string values. Check the Serial Monitor output of the ESP8266 device to find out. If the Google Assistant doesn't hear the user properly, use the Google Allow app, users can see what the Assistant heard, or can directly type the phrase which the user want it to interpret. If the Google assistant doesn't respond with the correct phrase, then Google account and IFTTT account aren't connected. Make sure that the same Google accounts for the Google assistant and IFTTT is used. If the Adafruit IO dashboard doesn't update when the IFTTT applet triggers, then Adafruit IO account and IFTTT account aren't connected. Double check on IFTTT to make sure that both the accounts have been linked.

Methodology

The methodology of this project design includes implementation of the proposed method. There are some basic steps involving in the Methodology of the product. The first major step is setting up the Adafruit IO. Adafruit IO is a website used to create virtual switches which will be turned ON or OFF depending on the commands given to the Google assistant and the second step is connecting the ESP8266 and the last step is connecting to Google assistant through IFTTT. IFTTT is also a website used to create simple chain of conditional statements for like if else statements. By following

these three steps, the implementation of the proposed system is going to be done.

- The system design is broken down into two main categories,
- The hardware- It has the capability to connect to the router. It would also be able to turn on/off specified devices, such as lights and fans. It is called the 'Control Unit'. And,
- The Software- The Blynk app, the IFTTT app and the Google Assistant constitute the software of the design and these applications would be integrated in the Android device. The Control Unit comprises of the microcontroller-NodeMCU and the 4/8 Channel Relay board. Relay board uses Node MCU(ESP 8266) to control the relays. The Blynk app on an Android device communicates with the microcontroller and sends the desired signal via the internet. Figure 1 below shows the basic system design architecture:
- The hardware also called the Control Unit comprises of the NodeMCU microcontroller and the Relay board. NodeMCU's digital output pins are connected to the Relay pins of the Relay board. Finally, each Relay is connected to an appliance.

Architecture

The hardware architecture of this system consists of Node MCU and smartphone. The wireless communication between the smartphone and the Node MCU is done over the Internet. Android OS has a built-in voice recognizing feature named Google assistant which is used to develop a smartphone application which has ability to control the home appliances from user voice command. This application converts the user voice command into text, then it transmit that text message to Adafruit libraries which is connected with Node MCU through IFTTT website which is abbreviated as IF THIS THAN THAT and is a website used to create a simple chain of conditional statements called applets.

One advantage of voice-controlled home automation system is that user only pronounce the appliance name in smartphone microphone and telling it to switch ON or OFF the appliances, in this way the users can control home appliance

easily without any effort. A voice recognition application provided a user-friendly interface to users and it has ability to add more home appliances into the system. This home automation system can be used in every building using electrical appliances and devices. The main drawback of system is that it is failed to work efficiently in a noisy environment. The main advantage is that its range can be extended as we are using Internet instead of Bluetooth as Bluetooth has the limited range but this solution will not be cost effective. Another advantage of using Google assistant-controlled Home automation is that it is totally of wireless communication.

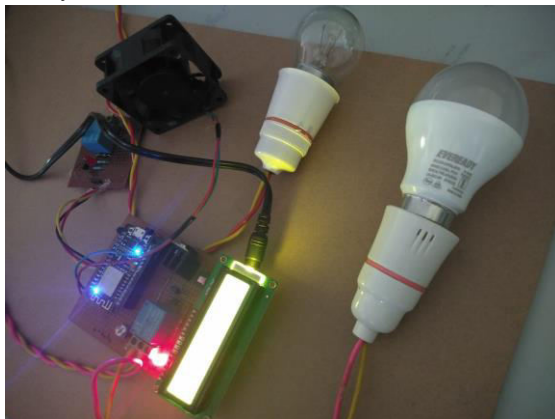

Fig 10 : Smart Home Architecture

Experimental Results

In this project we controlled three devices (Two bulbs and a fan) . Through specific voice commands or through Blynk app we can control required device.

The bulb 1 will get switched ON after providing with proper voice commands through Google Assistant or Blynk App .

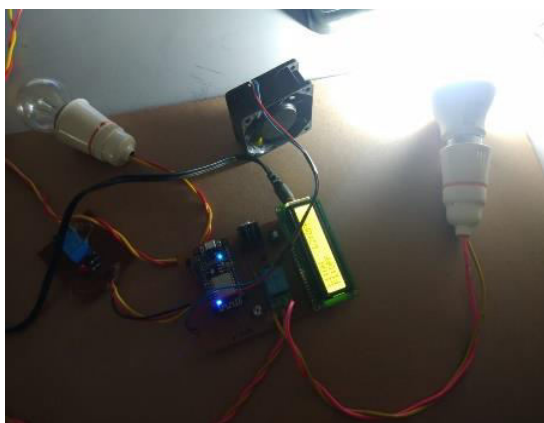

Fig 11 : Bulb 1 Switched ON



Fig 12 : Fan Turned ON

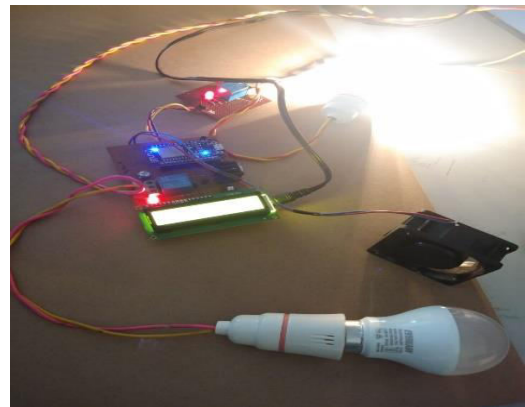

Fig 13 :Bulb 2 Switched ON

APPLICATIONS

Remote home monitoring allows users to manage and control various aspects of home. These include

- Motion detection
- Water leak detection
- Monitoring temperature against burglary and fire
- Controls for lights, locks, fans and more from Laptop or Tablet or Smartphone.
- Lighting Control System
- Appliance control with a smart grid
- Indoor positioning systems
- Home automation for elderly and disabled people
-

CONCLUSIONS & FUTURE SCOPE

In this project, voice commands are given to the

Google assistant. The voice commands for Google assistant have been added through IFTTT website and the Adafruit account is also linked to it. In this home automation, user have given commands to the Google assistant. Home appliances like Bulb, Fan and Motor etc., are controlled according to the given commands. It has added advantages like

- 1) Reduced installation costs.
- 2) Easy deployment, installation, and coverage.
- 3) System scalability and easy extension.
- 4) Aesthetical benefits.
- 5) Integration of mobile devices.

For all these reasons, wireless technology is not only an attractive choice in renovation and refurbishment, but also for new installations.

There are a variety of enhancements that could be made to this system to achieve greater accuracy in sensing and detection.

a) There are a lot of other sensors that can be used to increase the security and control of the home like pressure sensor that can be put outside the home to detect that someone will enter the home.

b) Changing the way of the automated notifications by using the GSM module to make this system more professional.

c) A smart garage that can measure the length of the car and choose which block to put the car into it and it will navigate the car through the garage to make the parking easy for the homeowner in his garage.

BIBLIOGRAPHY

[1]. Tan, Lee and Soh – “Internet based Monitoring of Distributed Control Systems”, Energy and power Engineering. Publisher: IEEE Transactions on Education, Place: New Jersey, Country: USA, Year: 2002, Vol: 45, Iss. No. 2., pp. 128-134.

[2]. Potamitis, I., Georgila, K. Fakotakis, N., & Kokkinakis, G – ‘An Integrated system for smarthome control of appliances based on remote speech interaction’,- 8 th European conference on speech and communication technology, Publisher: World Journal control science and Engineering, Place: Geneva, Country: Switzerland, Year: 2003, Vol. No: 2, Iss. No.1, pp. 2197-2200.

[3]. S. M. Anamul Haque, S. M. Kamruzzaman and Md. Ashraful Islam – ‘A System for SmartHome Control of Appliances Based on Time and Speech Interaction’,- Proceedings of 4th International Conference on Electrical Engineering, Place: Bhubaneswar, Country: India, Year:2006., pp.128

to 131.

[4]. N. P Jawarkar, V. Ahmed, S.A. Ladhake, and R.D Thakare – ‘Microcontroller based Remote monitoring using mobile phone through spoken commands’,- Journal of networks, Publisher: World Journal control science and engineering, Place: Lagos, Country: Nigeria, Year:2008, Vol. No.:3, Iss. No.2, pp.58 to 83.

[5]. Prof. Era Johri– ‘Remote Controlled HomeAutomation using Android application via Wi-Fi connectivity’, - International Journal on Recent and Innovation and recent trends in computing and communication, Publisher: World Journal control science and engineering.

[6] Manish Prakash Gupta,. Department of Electronics and Communication, Maharishi Dayanand University, Rohtak, Haryana, India, “Google Assistant Controlled Home Automation” Volume: 05 Issue: 05 | May-2018

[7]Aayush Agarwal, Anshul Sharma, Asim Saket Samad and S Babeetha (2018) “UJALA- Home Automation System Using Google Assistant” Volume: 04 Issue: 02 | 2018

[8].Md Sarwar Kamal in (2017)“Efficient low-cost supervisory system for Internet of Things 2017).

[9].Nikhil Singh, Shambhu Shankar Bharti, Rupal Singh, Dushyant Kumar Singh “Remotely controlled home automation system”, Publisher: IEEE International Conference on Advances in Engineering and Technology Research (ICAETR 2014).

[10].Sean Dieter Tebie Kelly, Nagender Kumar Suryadevara , Subhas Chandra Mukhopadhyay (2013) “Towards the Implementation of IOT for Environmental Condition Monitoring in Homes” Publisher : IEEE Sensors Journal 13 October 2013